

Data Sheet



Article number: 5863502814

Description: Ball Valve 350.2814, G 1 1/2" - G 1 1/2"
Thread/Thread

Measures

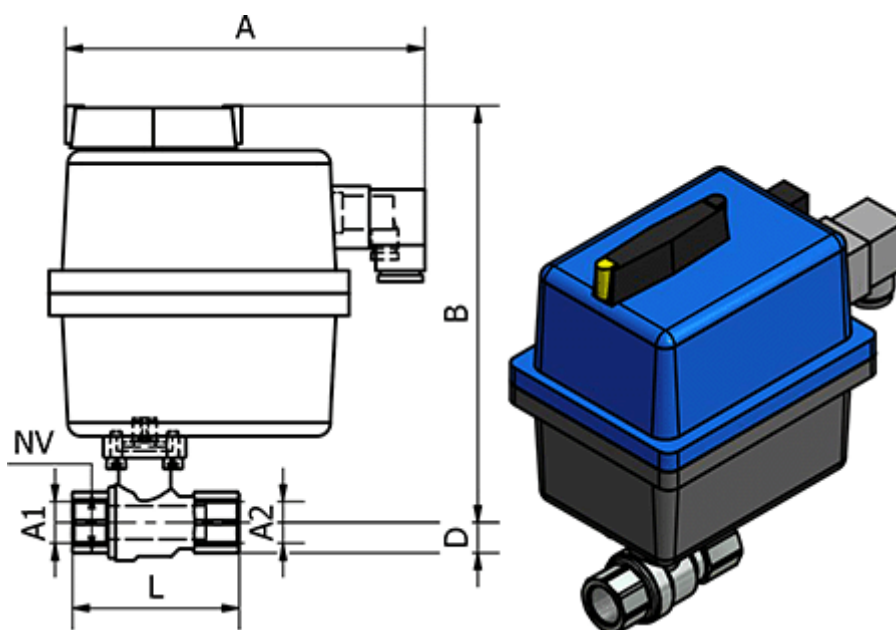

= -	D	= 36
= -	L	= 120
= -	Max. Operating Pressure	= 25 bar
= -	NV	= 55

A = 177

B = 223

Connecting A1 = G 1 1/2"

Connecting A2 = G 1 1/2"